

INNOVATIONS IN METROLOGY

# CT PRODUCT RANGE

Our solutions for your measuring tasks



# OVERVIEW

# CT PRODUCT RANGE

## WHAT IS VOLUME MEASUREMENT TECHNOLOGY? AN OVERVIEW OF COMPUTED TOMOGRAPHY

Computer tomographs are best known from the field of medical technology. They represent a further development of the classical X-ray technology.

While radiography X-ray machines are creating two-dimensional radiographic images of objects, computed tomographic volume measurement technology from WENZEL generates three-dimensional volume data. The scanned data can be used to reconstruct a complete dataset of materials and geometry.

Use in the industrial sector has proven itself in practice and the market potential increases continuously. The technology in the WENZEL computer tomographs is designed for applications in a wide variety of indus-

tries where the internal and external structures of the components are captured completely and holistically.

The picture below illustrates the functional principle of computer tomography: The component is X-rayed and shot in the optical path.

For the CT scan, the object is rotated 360°. During the rotation, two-dimensional radiation images are recorded by the detector using X-rays. In the computer, the component is calculated (reconstructed) as a 3D volume model from the radiographic images. Surface data is generated from this solid model, which forms the basis for all subsequent evaluations. Small components are measured near the X-ray source and

Functional principle of a computer tomograph: The component is X-rayed and rotated in the beam path and a three-dimensional model is reconstructed from multiple two-dimensional projections.

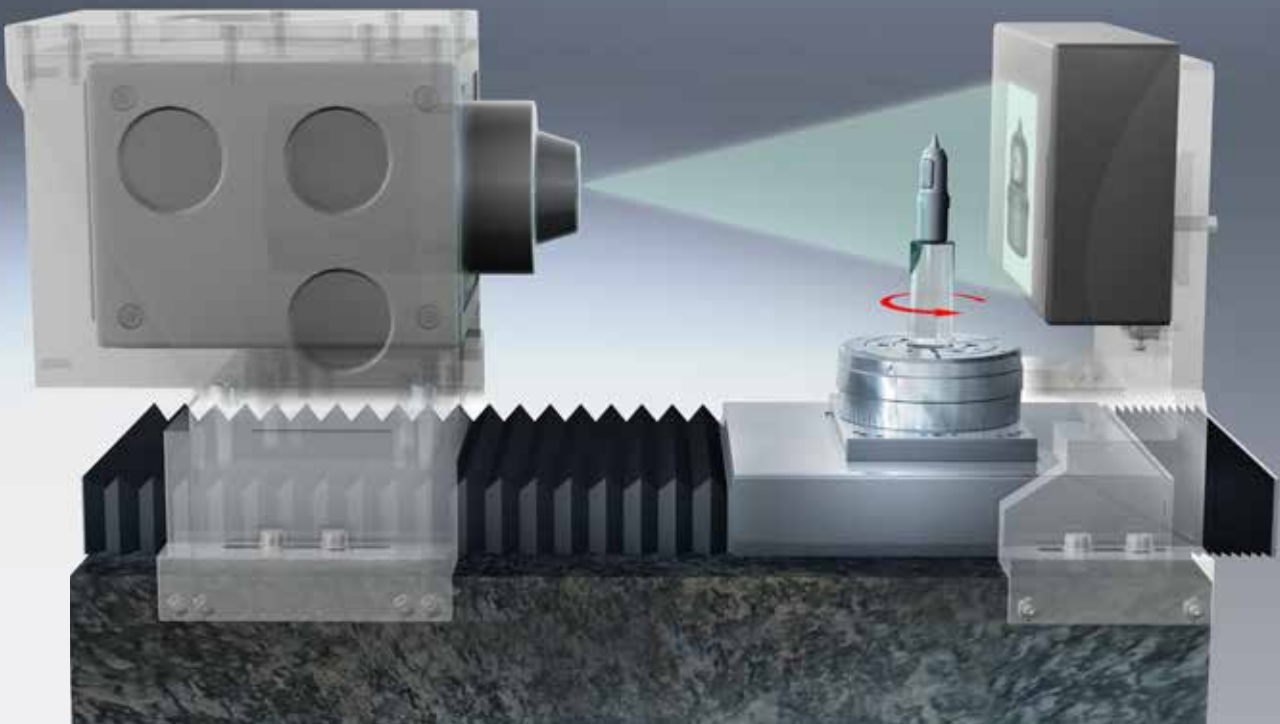



The exact computer tomographs from WENZEL have an innovative system concept. WENZEL has consistently focused on the needs of the user.

larger components near the detector. Even the smallest details can be resolved by magnification. From this volume data surface models are created forming the basis of all subsequent evaluations. Small components are measured close to the X-ray source and larger components nearer the detector. Due to the magnification, even the smallest details can be resolved.

Compact and powerful Computed Tomography Systems from WENZEL offer an unmatched ability to non-destructively test every aspect of a part and capture its very DNA.

CT Systems play an increasingly important role as measuring devices. The advantage over tactile or optical systems lies in the fact that the X-rays measure hidden features in a part and the measurement data is recorded non-destructively. Virtual programming and measuring of that data is supported by intelligent software products. This method of measurement offers the only solution to the quality assurance challenges of complex 3D-printed components.

# OVERVIEW

# CT PRODUCT RANGE

## VOLUME MEASUREMENT „MADE BY WENZEL“

Since 2008 WENZEL has been one of the innovators among the CT manufacturers and offers high performance and precise equipment with which 3D measurements of internal and external structures of objects can be carried out without contact and non-destructively. The WENZEL CT product range is broadly based and covers a wide range of applications.

When the name WENZEL appears on a device, this means innovation. The exaCT series combines decades of experience in measurement technology, outstanding WENZEL quality with the highest level of competence in

CT development. A modular system concept and an innovative detector technology enables a large number of device variants that allows adaptation to different customer requirements.

Tactile and optical measuring systems are limited to measuring only what they can reach or see inside a component but exaCT CT technology allows the measurement of any feature in the part even if hidden inside. Additionally, the high rate of data acquisition means that all the data from all of the component can be gathered in a very short length of time.

## HIGHLIGHTS

- Better performance thanks to impressive speed**  
 Quick Scanning | Quick Reconstruction | Fast evaluation
- Low operating costs**  
 Precision mechanics for guaranteed high machine availability | Long calibration intervals
- High efficiency due to low space requirement**  
 Largest measuring volume with smallest footprint | Production-compatible setup | Desktop versions for easy loading
- Flexible solutions**  
 Wide range of applications | Newest technologies | Easy operation
- One scan, many evaluations, maximum saving of time**  
 High-precision measurement results with virtual coordinate measuring machine (CMM) | Non-destructive testing (NDT) and defect analysis | Microstructure analysis of materials

**exaCT®S**

The compact **desktop CT exaCT S** is designed to be the ideal solution for volume measurement of small components. It can be placed on a desk and offers the highest performance in the smallest space.

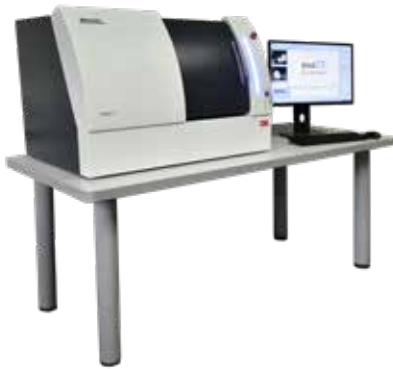
**exaCT S 80**

Space Requirements (L x B x H)	635 x 890 x 605 mm
X-Ray (Voltage, Power)	80 kV, 40 W
Detector Resolution	1000 x 690 Pixel, 100 µm
Work Piece Dimensions	Ø 80 x 45 mm*

**exaCT S 130**

Space Requirements (L x B x H)	635 x 890 x 605 mm
X-Ray (Voltage, Power)	130 kV, 39 W
Detector Resolution	2300 x 1300 Pixel, 50 µm
Work Piece Dimensions	Ø 85 x 45 mm*

**exaCT®M**

The **exaCT M CT workstation** is a modularly constructed system with integrated desk, where measuring and evaluation functions have been integrated in a perfectly designed workstation. Its applications are the measuring and testing of small to medium-sized components and assemblies of single or mixed materials.

**exaCT M 225**

Space Requirements (L x B x H)	1275 x 2315 x 1415 mm
X-Ray (Voltage, Power)	225 kV, 800 W
Detector Resolution	3600 x 1000 Pixel, 50 µm
Work Piece Dimensions	Ø 150 x 250 mm*

**exaCT®U**

The **powerful universal system exaCT U** is configurable and can be adapted to individual user requirements due to its high measuring volume large components with higher densities made of plastic, metal or multi-materials can be scanned.

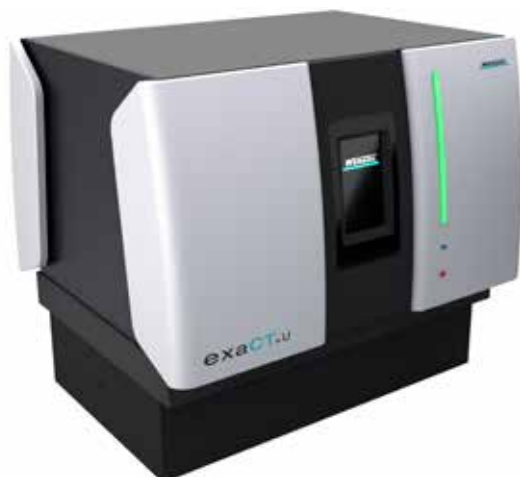
**exaCT U 225**

Space Requirements (L x B x H)	1960 x 2350 x 2400 mm
X-Ray (Voltage, Power)	225 kV, 300 W
Detector Resolution	2900 x 2900 Pixel, 150 µm
Work Piece Dimensions	Ø 330 x 700 mm*

**exaCT U 300**

Space Requirements (L x B x H)	1960 x 2350 x 2400 mm
X-Ray (Voltage, Power)	300 kV, 300 W
Detector Resolution	4000 x 4000 Pixel, 100 µm
Work Piece Dimensions	Ø 330 x 700 mm*

\* Depending on the part diameter

# FIELDS OF APPLICATION

## exaCT IS THE SOLUTION FOR MANY TASKS

Computed tomography makes it possible to perform measurements on a very broad range of parts from plastic parts to fibre composite components up to and including light metal parts. The density of the material as well as the geometry and wall thicknesses of the objects ultimately determine if they can be measured this way.

The exaCT S has a measuring volume of 45 mm in height, 85 mm in diameter and voltage of up to 130 kV.

The exaCT M has a measuring volume of 300 mm in height, 200 mm in diameter and voltage of up to 225 kV.

The exaCT U has a measurement volume of 700 mm in height, 330 mm in diameter and a voltage of up to 300 kV.

## APPLICATION AREAS

MEASURING TECHNOLOGY	TESTING TECHNOLOGY
<b>Dimensional checks</b> Measurement of standard geometries and freeform surfaces including shape and position tolerances	<b>Material defect analyses</b> Non-destructive testing for e.g. blowholes, pores or cracks
<b>Wall thickness analysis</b> Color representation of component wall thickness distribution	<b>Structural analysis</b> Visualization of material and component structures
<b>Nominal-actual comparisons</b> Representation of deviation from CAD model or master component	<b>Assembly checks</b> Control of assembly results, functional and error analyses
<b>Tool and component optimization</b> Compensation of shrinkage and warpage	<b>Joining technology tests</b> Checking errors in welded, soldered, glued or riveted joints
<b>Development, Rapid Prototyping and Reverse Engineering</b> Creation of CAD models from the scan data	<b>Electronics testing</b> Inspection of soldered and glued joints



## FIELDS OF APPLICATION

### exaCT

Real life applications demonstrate the strengths of the exaCT systems. Here we show typical applications, which demonstrate the advantages of computer tomography. With exaCT volume measurement technology,

both material and geometry data of the entire component are available, multiple measurements and evaluations can be carried out on the basis of only one measurement.



PC wireless mouse



Side view into the partially opened housing. The position of the individual parts in relation to each other can be analyzed in the assembled state.

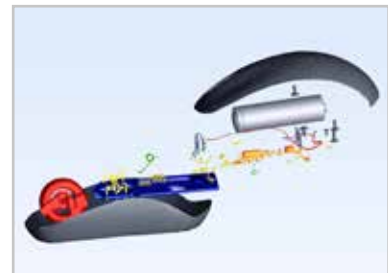

Exploded view of the wireless mouse. The individual parts can be virtually rearranged for better visualization.

### Blowhole analysis of an aluminium casting



Aluminium casting

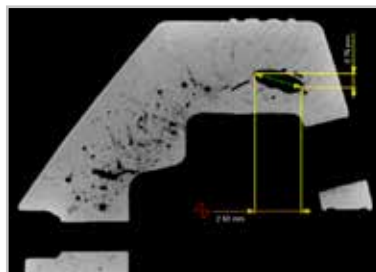

The 2D section shows blowholes and porosity in the component

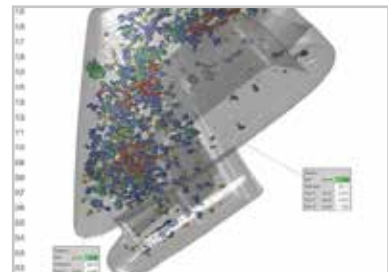

The 3D blowhole analysis shows the size, distribution and position of the blowholes in the component

### Dimensional measurement technology on a plastic injection-molded component



Injection-molded component with complex internal structures.

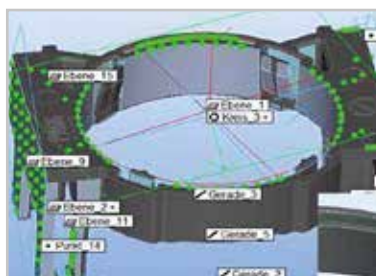

The measuring program includes internal and external structures. Virtual touch points are set for dimensional measurement.

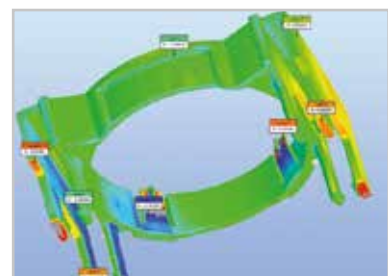

Nominal-actual comparison determines the deviations of the manufactured component from the CAD and makes them visible in a color-map.

# WENZEL exaCT® S SERIES

## NON-DESTRUCTIVE MEASURING & TESTING

The compact desktop CT exaCT S is the ideal solution for volume measurement of small components. It fits on any desk and offers maximum performance in the smallest space. The high resolution enables detailed evaluations of even the smallest components, ranging from micro-measurement to micro-material testing.

The exaCT S in compact design and sophisticated ergonomics combines performance and flexibility in the smallest space. The maintenance-free radiation source ensures low operating costs with high reliability.

## FEATURES

- **Space-saving desktop CT** through compact integration of the complete electronics and control system
- **High power** of from 80 up to 130 kV with integrated vibration damping
- **Flexible system** with compact design and sophisticated ergonomics
- **Fast set-up of workpieces** thanks to integrated video cameras and special software features
- **Easy operability** and **high performance** of the application software

## APPLICATIONS

The exaCT S is the first choice for measuring and testing components with low material densities. Despite its compact system size, the system offers a measuring volume of up to 45 mm in height and 85 mm in diameter. The exaCT S is particularly suitable for non-destructive testing (NDT) of plastics, composites and multi-materials.

Connectors



Non-Destructive Testing (NDT)

Hearing aid



Assembly inspection

Insert ring



Metrology



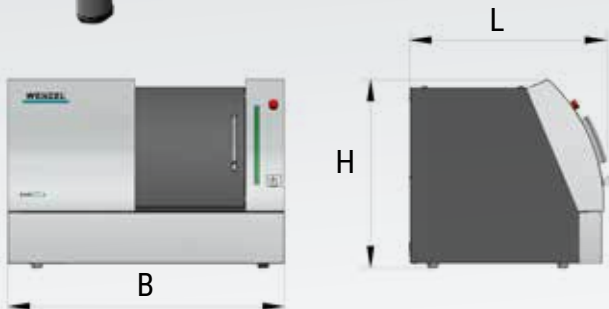

## MASHINE PROFILE

### exaCT S 80

Space Requirements (L x B x H)	635 x 890 x 605 mm
X-Ray (Voltage, Power)	80 kV, 40 W
Detector Resolution	1000 x 690 Pixel, 100 µm
Work Piece Dimensions	Ø 80 x 45 mm*

### exaCT S 130

Space Requirements (L x B x H)	635 x 890 x 605 mm
X-Ray (Voltage, Power)	130 kV, 39 W
Detector Resolution	2300 x 1300 Pixel, 50 µm
Work Piece Dimensions	Ø 85 x 45 mm*

\* Depending on the part diameter

## YOUR BENEFITS AT A GLANCE

- **Space-saving table installation**  
Integration of electronics and control in a compact system | No need for a separate control cabinet | Perfectly thought-out work ergonomics
- **Best performance through high efficiency**  
Optimized ratio of measuring volume to floor space | Efficient scanning and reconstruction processes | Suitable for workshops
- **One scan, maximum time saving**  
Measurement with virtual CMM | NDT and error analysis | Microstructure analysis
- **Flexible 'Plug and Play' solution**  
Micro metrology | Software for all applications | Quick set-up of workpieces
- **Low operating costs**  
Maintenance-free radiation source | Precision mechanics for higher availability | Longer calibration intervals

# WENZEL exaCT® M 225

## NON-DESTRUCTIVE MEASURING & TESTING

The exaCT M is based on a workstation-concept, which unites high X-ray performance and high scan speeds on a small footprint.

The exaCT M CT workstation has an integrated evaluation unit in a common desk workstation. The compact design, the well thought-out ergonomics and the idea to combine

more power and flexibility with less space requirements characterize the system. The workstation version enables easy loading and is ideally suitable for automating measuring and testing processes.

## FEATURES

- **Compact system** through the integration of computing power and control cabinet
- **High output** of 225 kV with a small space requirement
- **Sophisticated operating concept** automatically opens and closes the loading door at the right moment
- **Minimization of environmental influences** through integrated vibration damping
- **Easy operability** and **high performance** of the application software
- **Maintenance-free** or **low-maintenance** due to special stability of the X-ray source

## APPLICATIONS

With a measuring volume of 300 mm in height and 200 mm in diameter, the exaCT M workstation is used for measuring and testing technology for small to medium-sized components. The exaCT M is particularly suitable for non-destructive testing (NDT) of plastics, light metals, composites and multi-materials.

Remote control



Assembly inspection

Aluminum casting



Blowhole test

Hose Connectors



Measurement Technology

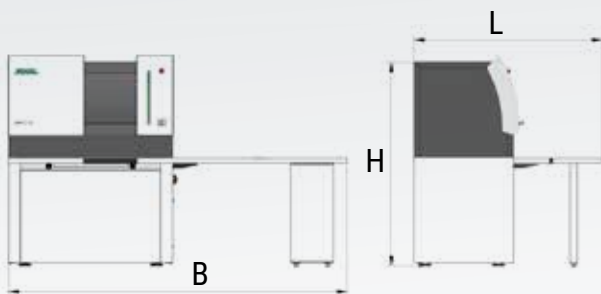

### exaCT M 225

Space Requirements (L x B x H)	1275 x 2315 x 1415 mm
X-Ray (Voltage, Power)	225 kV, 800 W
Detector Resolution	3600 x 1000 Pixel, 50 µm
Work Piece Dimensions	Ø 150 x 250 mm*

\* Depending on the part diameter

## YOUR BENEFITS AT A GLANCE

- **Flexible compact system**  
 Scanning of plastics, light metals and multi-materials | Various available configurations and detector resolutions | Integrated computer and control cabinet
- **High performance on a small footprint**  
 Best performance during scanning and reconstruction | Workstation version for easy loading | Suitable for workshops
- **One scan, maximum time saving**  
 Measurement with virtual CMM | NDT and error analysis | Microstructure analysis
- **Reliable measurement results**  
 High resolution | Powerful application software | Integrated vibration damping
- **Optimized operating costs**  
 Maintenance-free or low-maintenance radiation source | High availability due to precision mechanics | Longer calibration intervals

# WENZEL exaCT® U

## NON-DESTRUCTIVE MEASURING & TESTING

The exaCT U offers a simplified, cost-effective and fully automated workflow for the entire CT analysis process. Due to its high performance combined with a large measuring volume, the exaCT U enables the measurement and testing of large components with higher densities.

Due to intuitive user guidance, exact measurement results can be generated after a short training period. The exaCT U thinks along with you: Measurement parameters are automatically optimized by the system.

In its performance class, the exaCT U is one of the most compact computer tomographs on the market. It has five independent traversing axes and offers impressive resolution. Hardware and software offer the possibility of automated integration into the production line and deliver market-driven answers to questions about industry 4.0.

WENZEL was awarded the Customer Value Leadership Award 2017 from Frost & Sullivan for the exaCT U.

## FEATURES

- **Configurable system**, to address individual user requirements and automation
- **High power** from 225 kV up to 300 kV sets new standards for reconstruction speed
- **Large measuring volume** of 700 mm in height and 330 mm in diameter
- **High resolution** (2900 x 2900 pixels / 4000 x 4000 pixels) for measuring components with tight tolerances and complex structures
- **Five independent travel axes** for high speeds and short measuring and testing times

## APPLICATIONS

The exaCT U is universally applicable and can also scan large components with higher densities due to its high measuring volume. It is ideally suited for measuring and testing parts made of plastic, light metal, composite materials or multi-materials.

Vehicle headlamps



Assembly inspection

Internal combustion engine



Defect analysis

Titanium plastic implant



Metrology

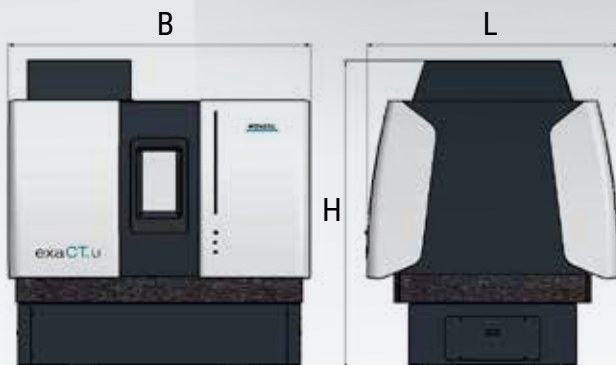
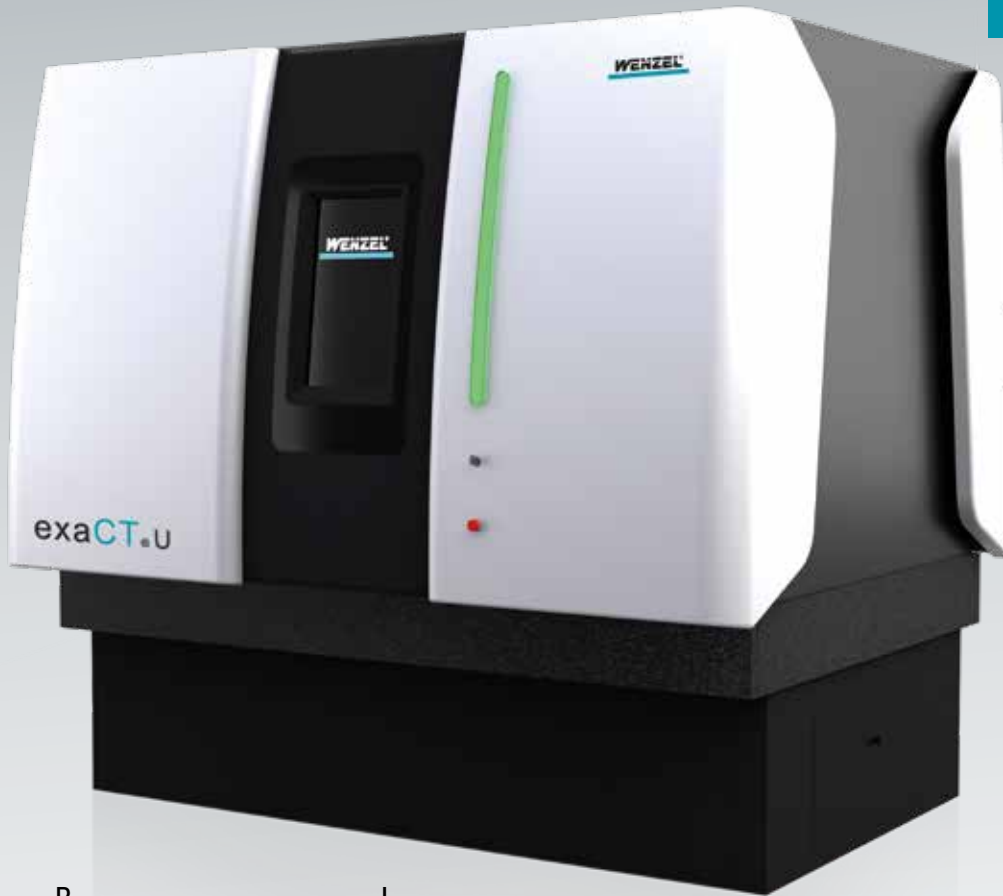

## MACHINE PROFILE

### exaCT U 225

Space Requirements (L x B x H)	1960 x 2350 x 2400 mm
X-Ray (Voltage, Power)	225 kV, 300 W
Detector Resolution	2900 x 2900 Pixel, 150 µm
Work Piece Dimensions	Ø 330 x 700 mm*

### exaCT U 300

Space Requirements (L x B x H)	1960 x 2350 x 2400 mm
X-Ray (Voltage, Power)	300 kV, 300 W
Detector Resolution	4000 x 4000 Pixel, 100 µm
Work Piece Dimensions	Ø 330 x 700 mm*

\* Depending on the part diameter

## YOUR BENEFITS AT A GLANCE

- **Best results through high performance**  
Fast scanning | Fast reconstruction | Fast evaluation
- **One scan, many evaluations, maximum time saving**  
Metrology with virtual CMM | NDT and error analysis | Microstructure analysis
- **High efficiency due to low space requirements**  
Large measuring volume | Suitable for workshops | Automation solutions
- **High flexibility**  
Various volumes and configurations | Software for all applications | Choice of radiation sources and detector resolutions
- **Low operating costs**  
Maintenance-free or low-maintenance radiation source | Precision mechanics for higher availability | Longer calibration intervals

## INNOVATION MEETS TRADITION

The WENZEL Group is a market leader in innovative Metrology. WENZEL offers a comprehensive product portfolio in the fields of Coordinate Metrology, Computed Tomography and Optical High Speed Scanning. The technology of WENZEL is used in all industries, including the automotive sector, aeronautics, power generation and

medicine. WENZEL looks at today on an installed base of more than 10,000 machines worldwide. Subsidiaries and agencies in more than 50 countries support sales and provide after-sales service for our customers. The WENZEL Group today employs more than 600 people.



## YOUR LOCAL CONTACT

### Wenzel America Ltd

28700 Beck Road

Wixom MI 48451 USA

Phone: +1 (248) 295 4300

E-Mail: [sales@wenzelamerica.com](mailto:sales@wenzelamerica.com)

[www.wenzelamerica.com](http://www.wenzelamerica.com)

Follow us & stay up to date!

